



GP 12340

12V 34.0Ah

GP 12340 is a general purpose battery with 3-5 years in standby service or more than 260 cycles at 100% discharge in cycle service. As with all CSB batteries, all are rechargeable, highly efficient, leak proof and maintenance free.

Specification

Cells Per Unit	6
Voltage Per Unit	12
Capacity	34Ah @ 20hr-rate to 1.75V per cell @25 °C (77°F)
Weight	Approx. 10.48kg(23.06lbs)
Maximum Discharge Current	400A(5sec)
Internal Resistance	Approx. 11 mΩ
Operating Temperature Range	Discharge: -15°C~50°C (5°F~122°F) Charge: -15~40°C (5°F~104°F) Storage: -15°C~40°C (5°F~104°F)
Nominal Operating Temperature Range	25°C±3°C(77°F±5°F)
Float Charging Voltage	13.5 to 13.8 VDC/unit Average at 25°C(77°F)
Recommended Maximum Charging	10.2A
Current Limit	
Equalization and Cycle Service	14.4 to 15.0 VDC/unit Average at 25°C(77°F)
Self Discharge	CSB Batteries can be stored for more than 6 months at 25°C(77°F). Please charge batteries before using. For higher temperatures the time interval will be shorter.
Terminal	Bolt & Nut
Container Material	-ABS (UL94-HB)*Flammability resistance of UL94-V0 can be available upon request.



CSB-manufactured batteries are UL-recognized components under UL924 and UL1989. CSB is also certified by ISO 9001 and ISO 14001.

Dimensions

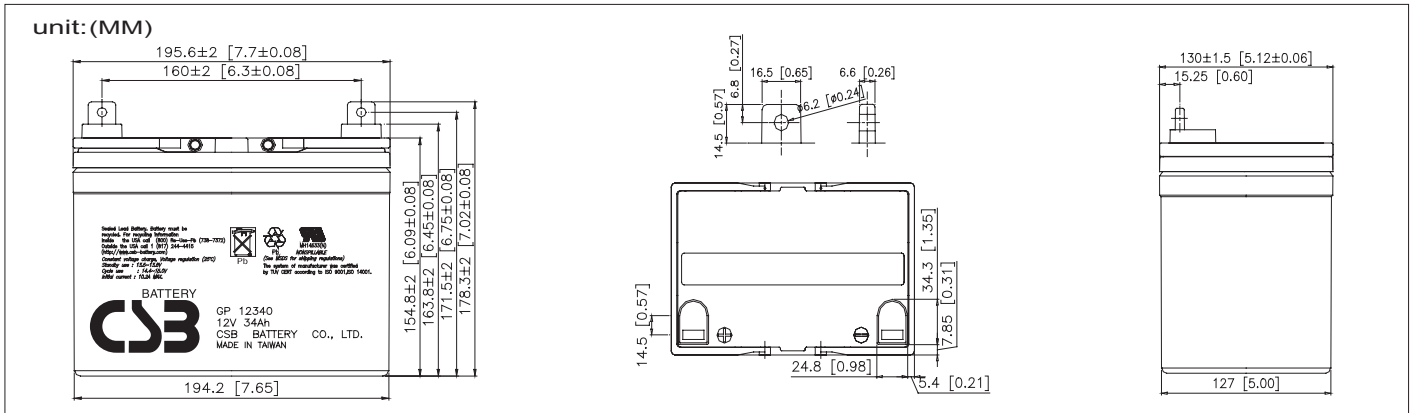

Constant Current Discharge Characteristics Unit:A (25°C, 77°F)

F.V/Time	5MIN	10MIN	15MIN	30MIN	1HR	2HR	3HR	4HR	5HR	8HR	10HR	20HR
1.60V	144.33	91.67	69.33	42.08	25.00	14.50	10.28	8.00	6.55	4.26	3.48	1.80
1.67V	128.23	85.48	66.18	41.44	24.88	14.44	10.27	7.99	6.51	4.24	3.43	1.72
1.70V	121.33	82.83	64.83	41.17	24.83	14.42	10.26	7.98	6.49	4.23	3.41	1.69
1.75V	109.67	77.54	61.79	40.17	24.42	14.30	10.18	7.94	6.47	4.19	3.36	1.64
1.80V	98.00	72.25	58.75	39.17	24.00	14.17	10.10	7.89	6.45	4.14	3.30	1.58
1.85V	86.34	66.96	55.71	38.17	23.59	14.05	10.02	7.85	6.43	4.10	3.25	1.53

Constant Power Discharge Characteristics Unit:W (25°C, 77°F)

F.V/Time	5MIN	10MIN	15MIN	30MIN	1HR	2HR	3HR	4HR	5HR	8HR	10HR	20HR
1.60V	1,732.00	1,100.00	832.00	505.00	300.00	174.00	124.00	96.00	78.60	51.10	41.70	21.60
1.67V	1,538.80	1,025.80	794.20	497.30	298.60	173.30	123.37	95.79	78.11	50.82	41.14	20.69
1.70V	1,456.00	994.00	778.00	494.00	298.00	173.00	123.10	95.70	77.90	50.70	40.90	20.30
1.75V	1,316.00	930.50	741.50	482.00	293.00	171.50	122.15	95.20	77.65	50.15	40.25	19.60
1.80V	1,176.00	867.00	705.00	470.00	288.00	170.00	121.20	94.70	77.40	49.60	39.60	18.90
1.85V	1,036.00	803.50	668.50	458.00	283.00	168.50	120.25	94.20	77.15	49.05	38.95	18.20

• All mentioned values are average values.

Trickle (or Float) Service Life

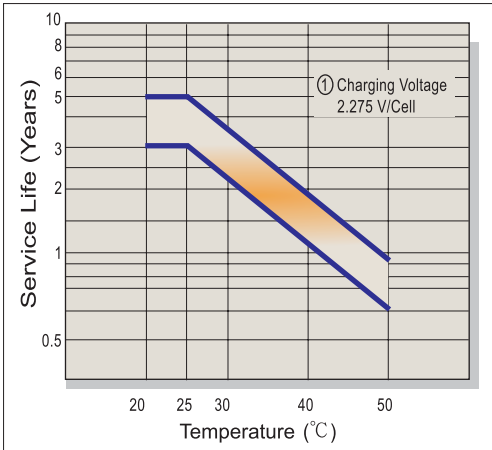

Capacity Retention Characteristic

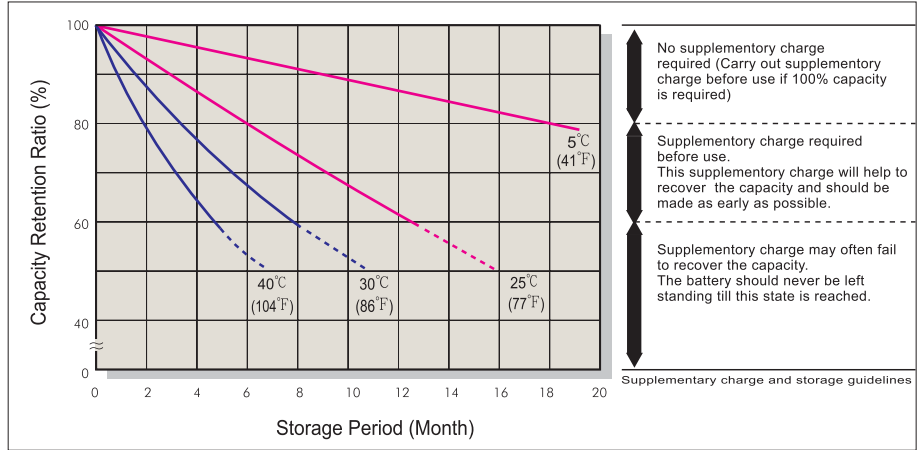

Battery Voltage and Charge Time for Standby Use

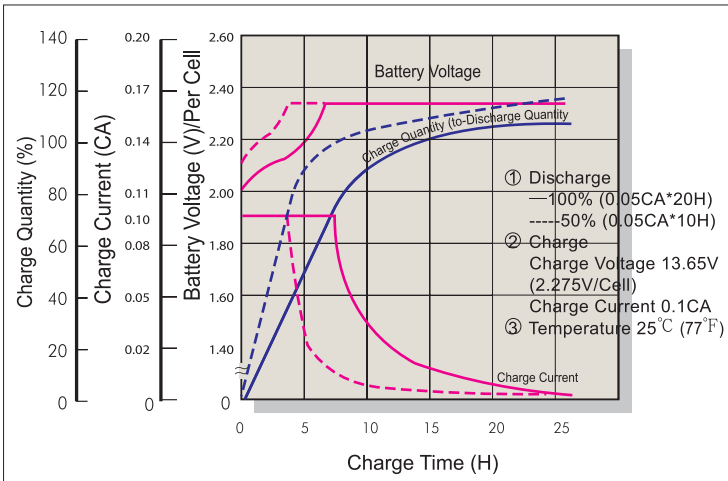

Cycle Service Life

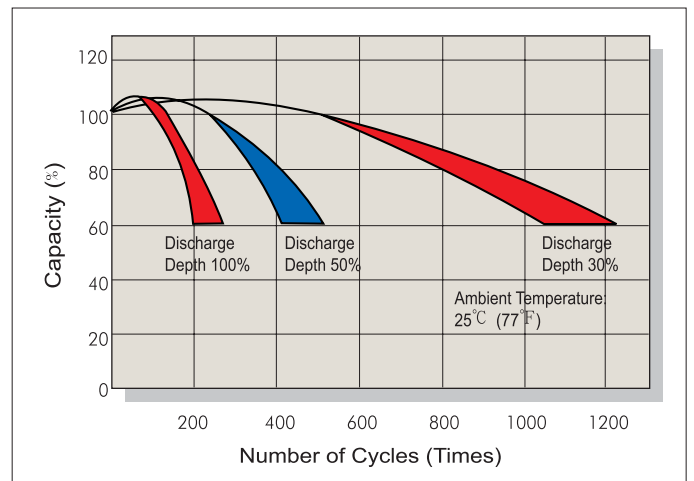

Battery Voltage and Charge Time for Cycle Use

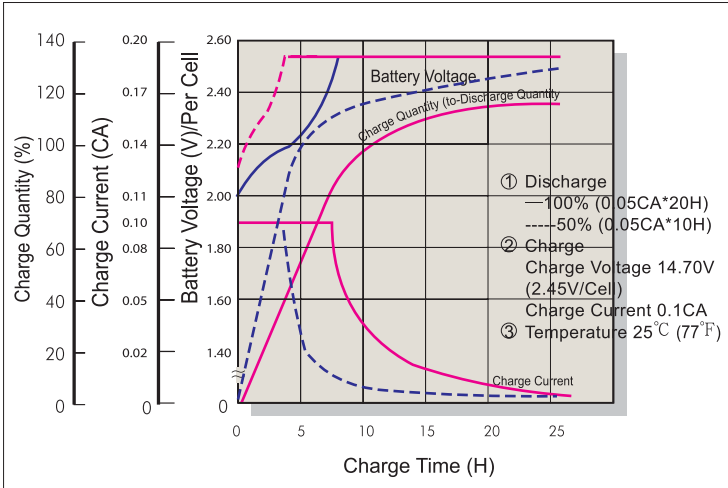

Terminal Voltage (V) and Discharge Time (25°C 77°F)

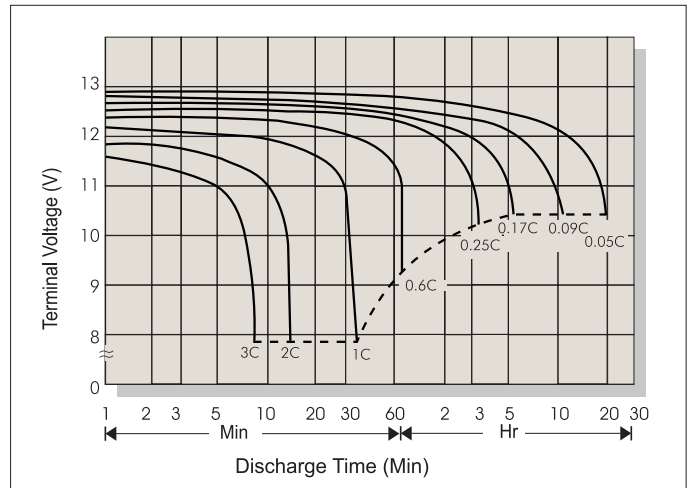

Charging Procedures

Application	Charge Voltage (V/Cell)			Max. Charge Current
	Temperature	Set Point	Allowable Range	
Cycle Use	25°C (77°F)	2.45	2.40~2.50	0.3C
Standby	25°C (77°F)	2.275	2.25~2.30	

Discharge Current VS. Discharge Voltage

Final Discharge Voltage V/Cell	1.75	1.70	1.55	1.30
Discharge Current (A)	0.2C > (A)	0.2C < (A) < 0.5C	0.5C < (A) < 1.0C	(A) > 1.0C

Sales Office URL: WWW.CSB-BATTERY.COM

CSB BATTERY CO., LTD.
TAIWAN OFFICE
Tel: +886-2-8751-5000
Fax: +886-2-8751-6161
E-mail: service@csb-battery.com.tw

CSB BATTERY LOGISTICS (SHANGHAI) CO., LTD.
SHANGHAI OFFICE
Tel: +86-21-5046-1622, 5046-0833
Fax: +86-21-5064-3314

CSB BATTERY TECHNOLOGIES, INC
USA OFFICE
Tel: +1-817-244-7777/1-8003 CSBUSA(272872)
Fax: +1-817-244-4445
E-mail: csb@csb-battery.com

CSB BATTERY LOGISTICS (SHANGHAI) CO., LTD.
BEIJING OFFICE
Tel: +86-10-6597-8060, 6597-8070
Fax: +86-10-6597-8050
E-mail: chinastls@csb-battery.com

CSB BATTERY OF NETHERLANDS B.V
NETHERLANDS OFFICE
Tel: +31(0) 180 418 140
Fax: +31(0) 180 418 327
E-mail: eurosales@csb-battery.com

CSB BATTERY LOGISTICS (SHANGHAI) CO., LTD.
SHENZHEN OFFICE
Tel: +86-755-88316356 88316488 88316396
Fax: +86-755-88316548
E-mail: she@csb-battery.com